

il Monoblocco thermik tipo Vicenza - F

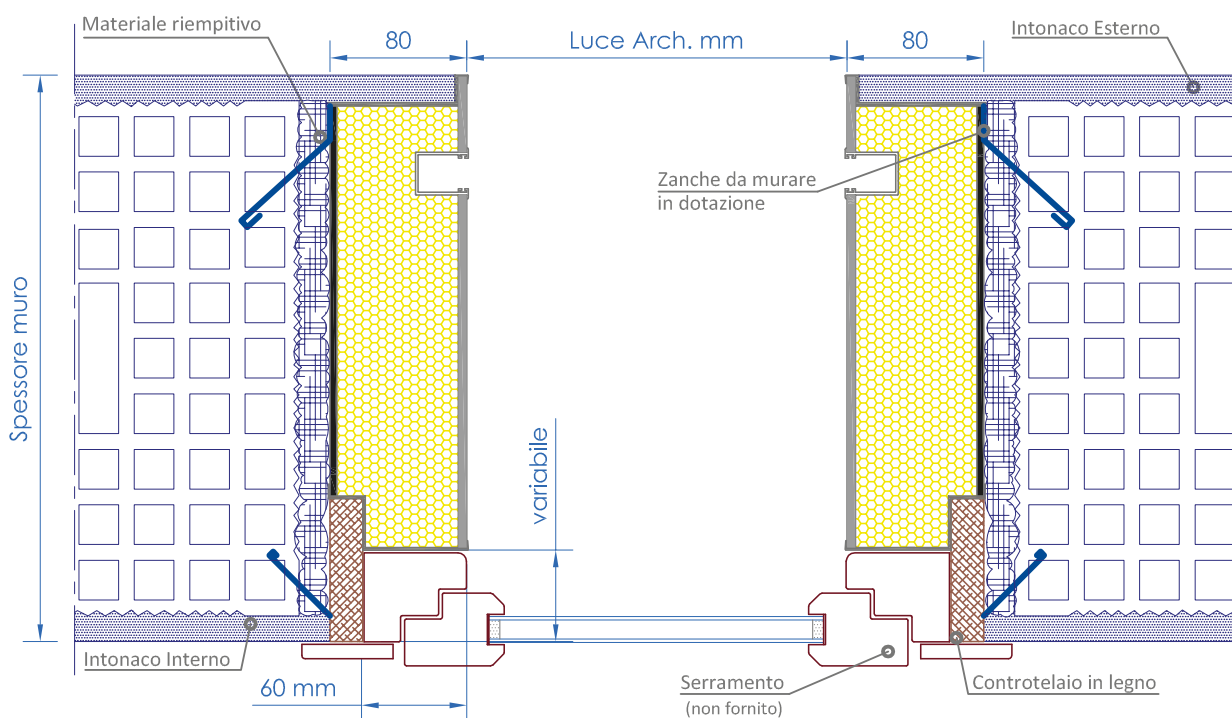

PREDISPOSIZIONE FORO GREZZO

Manovra Manuale dx

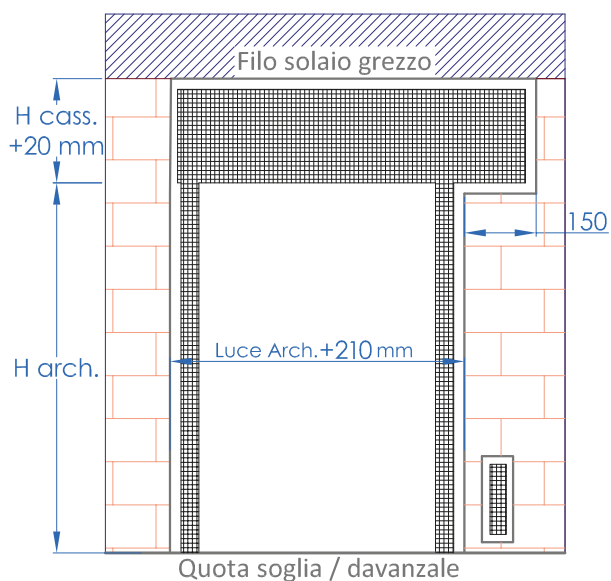

Manovra Motorizzata

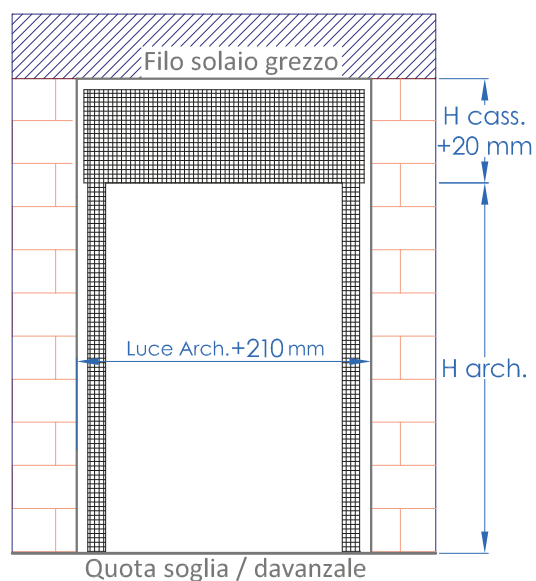

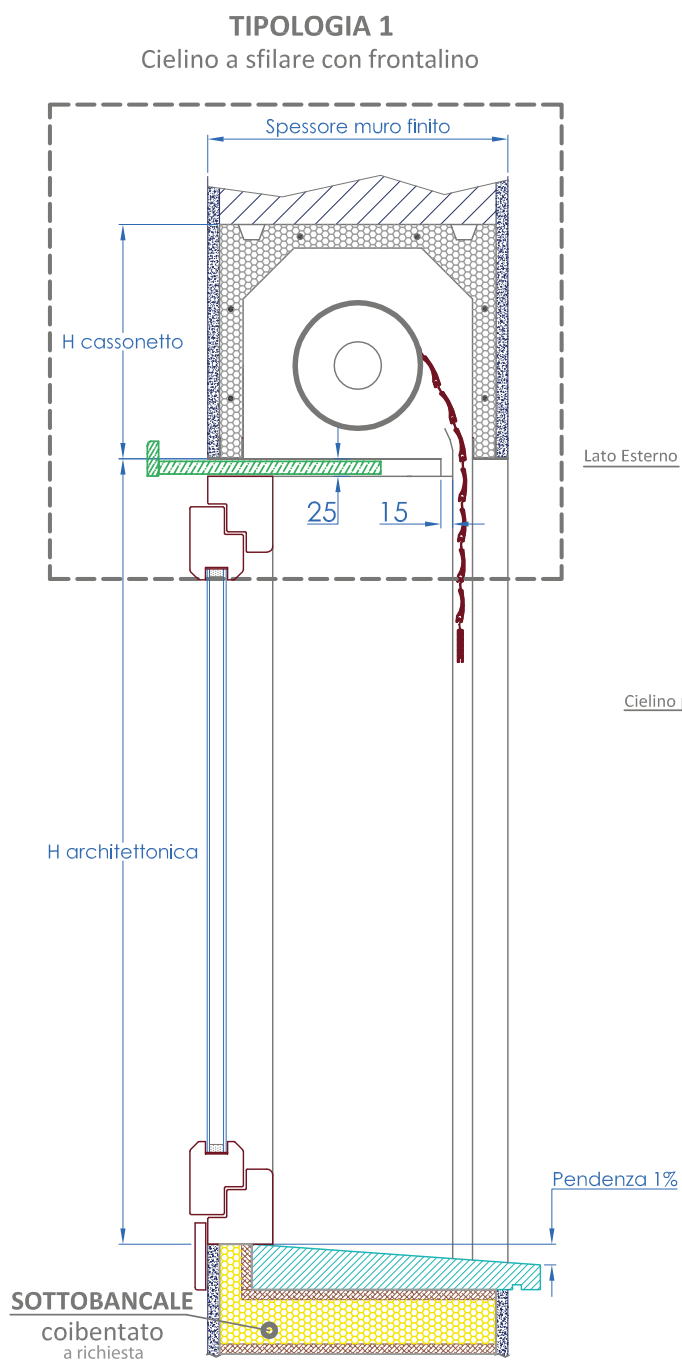

TIPOLOGIA 2
Cielino a sfilare solo tavoletta

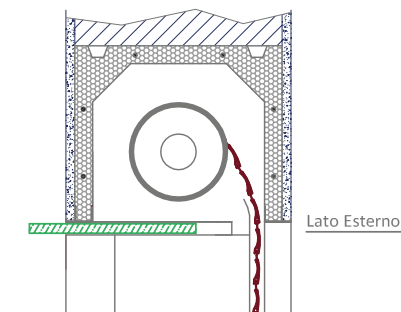

TIPOLOGIA 3
Cielino con ispezione frontale

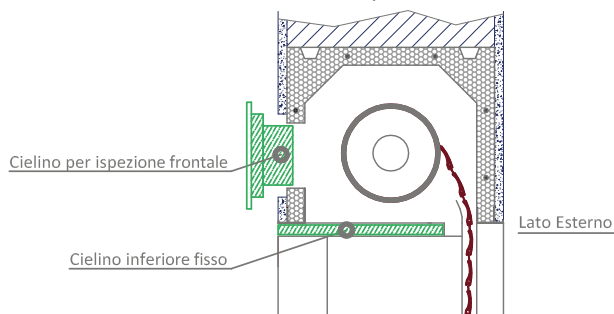

TIPOLOGIA 4
Cielino esterno con tavoletta a tampone

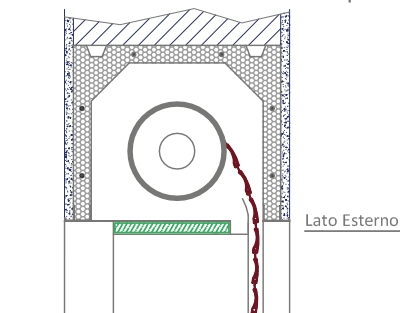

TRASMITTANZA TERMICA	POTERE FONOISOLANTE
Cassonetto: $U=1,1 \text{ W/m}^2 \text{ K}$	$R_w = 43 \text{ (-1;-6) Db}$ telo alzato $R_w = 45 \text{ (-1;-6) Db}$ telo abbassato
Prova di invecchiamento nel tempo:	Superata Certificato nr. 55 0036 10/2 rilasciato da TÜV Rheinland